



**PowerSafe**  
GU

---

PERFORMANCE  
SPECIFICATIONS

---

NEBS Certified





The PowerSafe GU product line ranges from 930Ah to 3900Ah, and is the largest clear flame retardant flooded cell in the industry. The PowerSafe GU battery features flat plate construction with calcium alloy grids ideal for any long duration float application. Since 1978, the GU has been the standard in the telecommunication industry. It is ideal for central office and mobile switch applications.

With the multi-directional design of the post, PowerSafe GU cells are easily configurable in any orientation, with cells either parallel to the rack support rails to optimize battery system footprint or perpendicular to the rails for easier element inspection. The new post design enables cell maintenance without taking the entire battery system offline. This is due to the ability to use four intercell connectors regardless of the cell orientation. Two connectors can be left in operation while the other two connectors are being remade.

The PowerSafe GU product line also employs EnerSys' exclusive Slide Lock™ post seal that allows natural plate growth over time without degrading the seal and an innovative tongue and groove jar-to-cover seal to prevent leaks.

### Features

- Capacity Range: 930Ah - 3900Ah
- Flat Plate construction-calcium grid alloys. Well suited for long duration, float applications.
- Largest single cell battery (up to 3900Ah) in a clear flame retardant jar.
- Optional flame retardant (UL94-VO/L.O.I. 32%) container.
- Slide Lock™ Post Seal allows natural plate growth without degrading post seal.
- Innovative tongue and groove jar-to-cover seal.
- Configurable with plates either parallel (optimize footprint) or perpendicular (inspection of the element) to rack support rails.

### Specifications

- Plate thickness:  
Positive: 0.30 in/7.6 mm  
Negative: 0.20 in/5.1 mm
- Plate dimensions:

	Height	Width
Pos:	17.6 in/447 mm	12.7 in/323 mm
Neg:	17.6 in/447 mm	12.7 in/323 mm
- Sediment space: 1.32 in/34 mm
- Electrolyte over plates: 3.40 in/86 mm
- Container:  
Styrene Acrylonitrile Copolymer, GU-09 to GU-45  
Optional flame retardant (UL94-VO/L.O.I. 32%) PC, GU-09 to GU-13  
Optional flame retardant (UL94-VO/L.O.I. 32%) PVC, GU-15 to GU-45
- Cover: Flame Retardant PVC, UL94-VO/L.O.I. 32%
- Separators: Microporous rubber
- Retainers: "Vitrex" - glass fiber
- Post type: Cast Lead Posts  
GU-9 through GU-13 Single Post  
GU-15 through GU-45 Double Posts
- Post seal type: Slide-Lock™
- Plate suspension type:  
Positive: Bridge hung  
Negative: Bottom supported
- Electrolyte withdrawal tube: One per cell
- Vent type: Flame Arrestor, Fused Alumina
- Float voltage setting:  
Acceptable min/max: 2.17/2.26Vpc  
Recommended: 2.25Vpc
- Specific gravity: 1.215 at 77°F (25°C)
- Bolt connectors: Stainless steel, standard English measure, hex-head
- Intercell connectors: Lead-plated copper
- All inter-cell, inter-tier, inter-step, end-to-end inter-rack, back-to-back inter-rack connectors, and terminal plates are included with every battery. Terminal lugs and across-aisle inter-rack connectors are not included.
- With 12 or more cells, the following accessories are included:  
Portable hydrometer, hydrometer holder - wall mount, thermometer, cell number sets, cell lifting device and flame arrestor

## General Specifications

Type*	Number of Cells	Nominal Voltage (V)	Nominal Capacity (Ah) @ 8hr rate to 1.75Vpc @ 77°F (25°C)	Nominal Dimensions***						Typical Weight							
				Length**		Width		Height		Unpacked		Domestic Packed		Electrolyte Only 1.215 S.G.			
				mm	in	mm	in	mm	in	kg	lbs	kg	lbs	kg	lbs	L	gal
2GU-9	2	4	930	315	12.4	384	15.1	693	27.3	166	367	175	387	62	136	51	13.6
2GU-11	2	4	1080	315	12.4	384	15.1	693	27.3	182	402	191	422	58	127	48	12.7
2GU-13	2	4	1220	315	12.4	384	15.1	693	27.3	198	436	207	456	53	118	45	11.8
GU-15	1	2	1680	315	12.4	384	15.1	693	27.3	157	347	166	367	65	144	54	14.4
GU-17	1	2	1800	315	12.4	384	15.1	693	27.3	165	364	174	384	63	140	53	14.0
GU-19	1	2	1960	315	12.4	384	15.1	693	27.3	173	382	182	402	62	136	51	13.6
GU-21	1	2	2110	315	12.4	384	15.1	693	27.3	182	401	191	421	60	132	50	13.2
GU-23	1	2	2540	384	15.1	422	16.6	693	27.3	219	483	229	505	84	185	70	18.5
GU-25	1	2	2720	384	15.1	422	16.6	693	27.3	227	501	237	523	82	181	68	18.1
GU-27	1	2	2880	384	15.1	422	16.6	693	27.3	236	520	246	542	80	177	67	17.7
GU-29	1	2	3030	384	15.1	422	16.6	693	27.3	244	538	254	560	78	173	65	17.3
GU-31	1	2	3180	384	15.1	422	16.6	693	27.3	253	557	263	579	77	169	64	16.9
GU-33	1	2	3300	384	15.1	422	16.6	693	27.3	264	583	274	605	75	165	62	16.5
GU-35	1	2	3430	384	15.1	422	16.6	693	27.3	273	601	282	623	73	161	61	16.1
GU-37	1	2	3540	384	15.1	422	16.6	693	27.3	281	620	291	642	71	157	59	15.7
GU-39	1	2	3650	384	15.1	422	16.6	693	27.3	289	638	299	660	69	153	58	15.3
GU-41	1	2	3730	384	15.1	422	16.6	693	27.3	298	657	308	679	67	149	56	14.9
GU-43	1	2	3820	384	15.1	422	16.6	693	27.3	306	675	316	697	65	144	55	14.4
GU-45	1	2	3900	384	15.1	422	16.6	693	27.3	314	693	324	715	63	140	53	14.0

\* Suffix number indicates total plates per cell. Prefix indicates number of cells per jar.

\*\* 0.25" must be added between cells for spacing purposes when calculating total battery length.

\*\*\*Overall dimensions represent the GU-9 thru GU-21 with plates oriented perpendicular to rack rails and GU-23 thru GU-45 with plates oriented parallel to rack rails. For optional GU-23 thru GU-45 with plates perpendicular to rack rails, length and width dimensions must be switched.

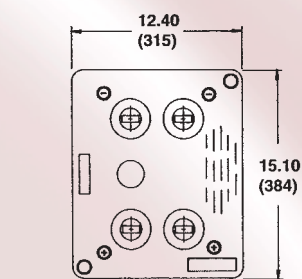

SINGLE CELL UNIT  
GU 15 TO 21 PLATE  
PERPENDICULAR PLATE ORIENTATION

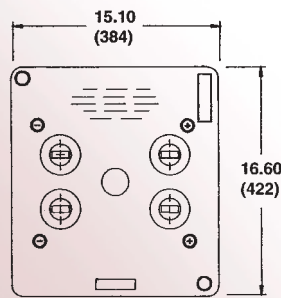

SINGLE CELL UNIT  
GU 23 TO 45 PLATE  
PARALLEL PLATE ORIENTATION

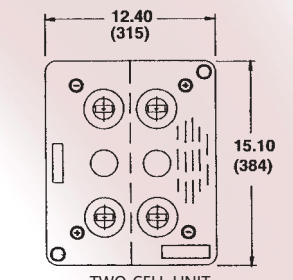

TWO CELL UNIT  
GU 9 TO 13 PLATE  
PERPENDICULAR PLATE ORIENTATION

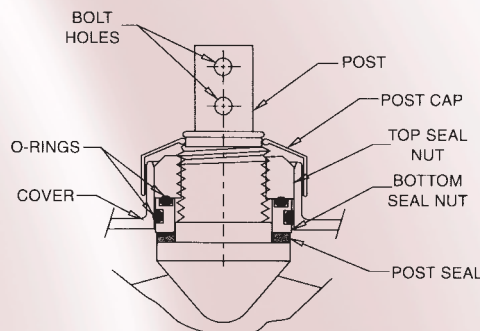

EXCLUSIVE SLIDE-LOCK™ POST SEAL

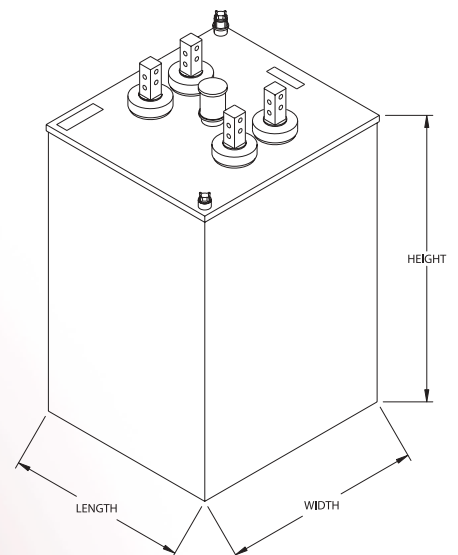

Discharge Rates in Amperes to 1.75Vpc at 25°C (77°F)\*

Type	Nominal <sup>1</sup> Capacity (Ah)	Minutes		Hours									
		15	30	1	1.5	2	3	4	5	8	12	24	72
GU-9	930	542	470	392	338	297	232	187	157	116	86	49	18.8
GU-11	1080	659	576	477	406	355	276	224	188	135	100	57	21.8
GU-13	1220	771	672	556	469	409	316	256	211	152	114	64	24.3
GU-15	1680	960	829	695	622	547	431	343	287	210	156	88	33.9
GU-17	1800	1084	940	785	677	593	466	377	316	225	169	96	36.5
GU-19	1960	1204	1051	865	748	653	512	414	350	245	184	105	39.8
GU-21	2110	1320	1152	955	813	712	555	451	378	264	199	113	43.0
GU-23	2540	1431	1251	1033	878	765	638	516	432	318	242	134	51.7
GU-25	2720	1542	1345	1111	939	818	682	552	466	340	256	142	54.4
GU-27	2880	1645	1437	1186	997	865	725	590	495	360	270	149	56.7
GU-29	3030	1748	1525	1258	1051	912	768	626	523	379	284	155	58.7
GU-31	3180	1846	1610	1326	1101	956	811	660	546	397	296	161	60.4
GU-33	3300	1928	1681	1345	1128	1014	816	663	556	412	301	164	60.5
GU-35	3430	2018	1759	1405	1173	1051	840	691	578	429	310	167	61.4
GU-37	3540	2106	1835	1462	1215	1085	862	718	598	443	318	171	61.9
GU-39	3650	2188	1906	1516	1254	1115	881	744	617	456	324	172	62.1
GU-41	3730	2267	1978	1567	1290	1143	896	767	635	466	330	174	62.1
GU-43	3820	2345	2041	1616	1323	1168	908	789	651	478	335	175	62.1
GU-45	3900	2419	2104	1661	1353	1190	918	810	665	487	338	176	62.1

Discharge Rates in Amperes to 1.81Vpc at 25°C (77°F)\*

Type	Nominal <sup>1</sup> Capacity (Ah)	Minutes		Hours							
		15	30	1	1.5	2	3	4	5	8	12
GU-9	930	422	380	333	297	267	213	174	147	110	82
GU-11	1080	514	466	405	357	319	253	207	176	128	96
GU-13	1220	601	544	472	412	368	290	238	198	144	109
GU-15	1680	749	671	591	546	491	394	318	270	198	149
GU-17	1800	845	760	667	595	534	427	350	297	213	162
GU-19	1960	939	851	735	658	587	471	384	329	232	176
GU-21	2110	1029	932	811	715	640	510	419	355	250	191
GU-23	2540	1116	1012	877	772	688	586	479	406	302	232
GU-25	2720	1202	1089	944	826	735	627	513	438	323	245
GU-27	2880	1282	1164	1007	877	779	666	548	465	342	259
GU-29	3030	1363	1235	1069	924	820	707	582	491	360	272
GU-31	3180	1440	1304	1127	968	860	746	614	513	377	284
GU-33	3300	1503	1362	1143	992	912	750	616	522	391	288
GU-35	3430	1574	1425	1194	1032	946	773	643	543	407	297
GU-37	3540	1636	1486	1243	1069	975	793	667	562	420	305
GU-39	3650	1706	1543	1288	1103	1003	810	691	579	433	311
GU-41	3730	1768	1602	1332	1135	1029	824	713	596	442	316
GU-43	3820	1829	1653	1373	1164	1051	835	733	611	454	321
GU-45	3900	1886	1704	1412	1190	1070	844	752	625	461	324

\*Ampere values listed represent 100% of the cell's capacity. Initial capacity shall be a minimum of 90% of these values per IEEE 450.

\*\*1.215 S.G. electrolyte at 77°F (25°C) includes intercell connector drop.

<sup>1</sup>Nominal AMP hour capacity at the 8 hour rate.

All data subject to change without notice.

Discharge Rates in Amperes to 1.84Vpc at 25°C (77°F)\*

Type	Nominal <sup>1</sup> Capacity (Ah)	Minutes		Hours							
		15	30	1	1.5	2	3	4	5	8	12
GU-9	930	357	328	293	267	243	197	163	138	104	78
GU-11	1080	435	403	357	320	290	234	194	165	121	91
GU-13	1220	508	470	416	370	335	268	222	185	136	103
GU-15	1680	633	580	521	491	448	366	298	252	168	142
GU-17	1800	715	657	588	534	486	396	328	278	202	153
GU-19	1960	794	735	649	590	535	435	359	308	220	167
GU-21	2110	871	806	715	642	583	472	392	332	237	181
GU-23	2540	944	876	774	693	627	542	448	380	286	220
GU-25	2720	1017	941	833	741	671	579	480	410	306	232
GU-27	2880	1086	1005	889	787	709	616	513	435	324	245
GU-29	3030	1153	1067	943	830	747	653	544	460	341	258
GU-31	3180	1218	1127	995	869	783	688	574	480	357	269
GU-33	3300	1272	1176	1009	891	830	693	577	489	370	273
GU-35	3430	1332	1231	1053	926	861	714	600	508	386	282
GU-37	3540	1389	1284	1096	959	889	732	624	526	398	289
GU-39	3650	1443	1334	1137	990	915	748	647	542	410	294
GU-41	3730	1495	1384	1175	1019	937	761	667	558	419	300
GU-43	3820	1547	1428	1211	1045	957	771	686	572	430	304
GU-45	3900	1595	1472	1245	1068	975	780	703	585	437	307

Discharge Rates in Amperes to 1.88Vpc at 25°C (77°F)\*

Type	Nominal <sup>1</sup> Capacity (Ah)	Minutes		Hours							
		15	30	1	1.5	2	3	4	5	8	12
GU-9	930	276	258	243	226	207	173	145	125	95	72
GU-11	1080	336	317	295	272	248	207	174	150	110	84
GU-13	1220	392	369	344	314	285	237	200	168	124	95
GU-15	1680	490	455	430	416	382	322	267	229	172	131
GU-17	1800	552	517	486	453	415	349	294	252	184	141
GU-19	1960	613	578	536	501	456	383	322	280	200	154
GU-21	2110	672	634	592	544	497	416	351	302	216	167
GU-23	2540	729	688	639	588	536	478	402	345	260	203
GU-25	2720	786	740	689	629	572	511	431	372	278	215
GU-27	2880	839	790	734	667	606	544	459	396	295	226
GU-29	3030	891	839	779	704	638	576	488	418	310	238
GU-31	3180	941	885	822	737	668	608	514	436	325	248
GU-33	3300	983	924	833	755	709	612	517	444	337	252
GU-35	3430	1029	967	870	785	735	630	539	462	351	260
GU-37	3540	1073	1009	906	814	759	646	559	478	363	267
GU-39	3650	1115	1048	939	840	781	660	580	493	373	272
GU-41	3730	1156	1087	972	864	800	672	598	508	382	277
GU-43	3820	1195	1122	1001	886	817	681	615	520	391	281
GU-45	3900	1233	1156	1030	906	832	688	631	532	398	283

\*Ampere values listed represent 100% of the cell's capacity. Initial capacity shall be a minimum of 90% of these values per IEEE 450.

\*\*1.215 S.G. electrolyte at 77°F (25°C) includes intercell connector drop.

<sup>1</sup>Nominal AMP hour capacity at the 8 hour rate.

All data subject to change without notice.

AVERAGE CAPACITY OF MEAN – SIZE  
CELLS INCLUDING CONNECTORS

S-1063

EnerSys

TYPE: GU-9 TO 21

Temp.  
77° F (25°C)

DATE: 9/1/83

SP. GR.  
1.215

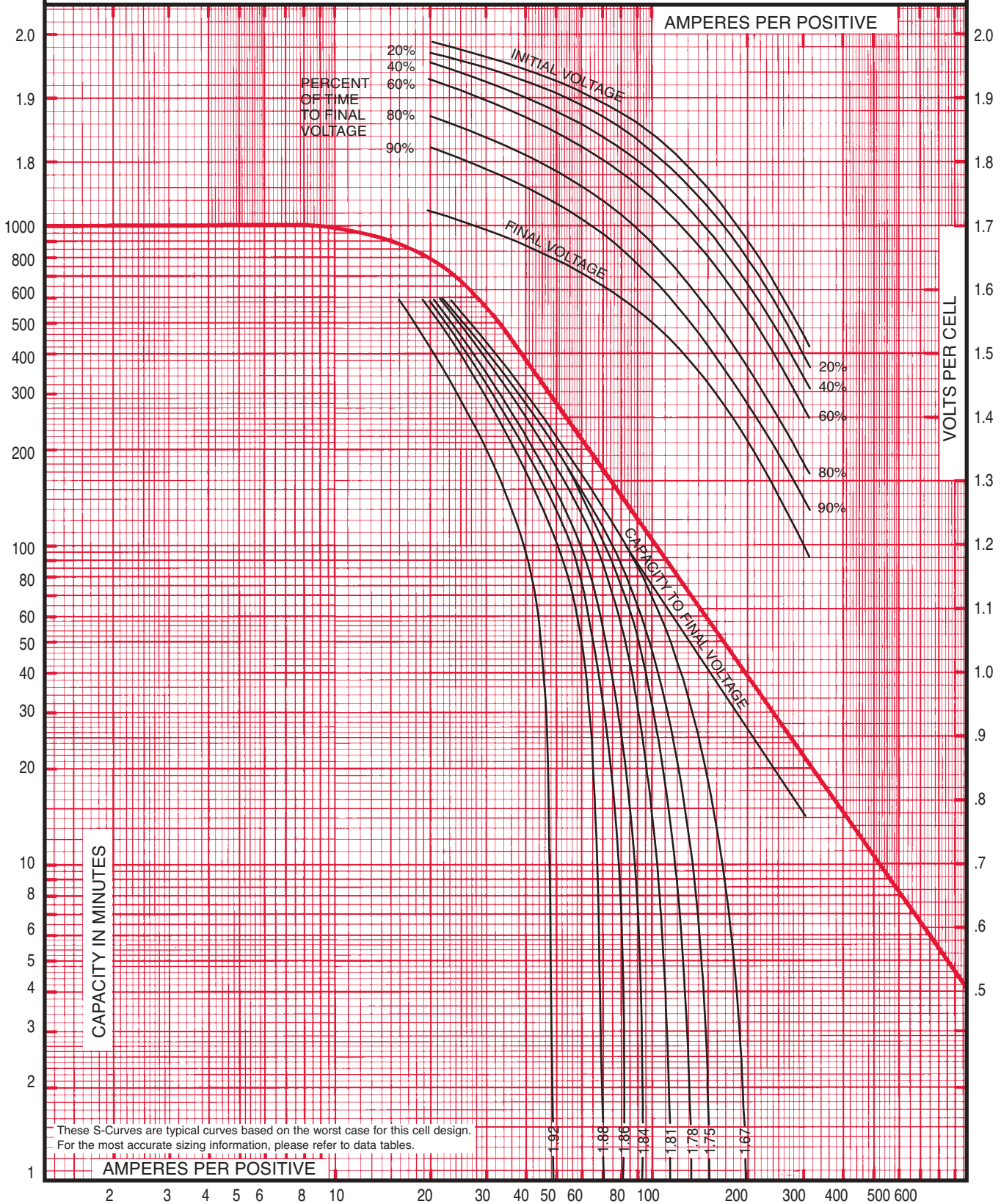

AVERAGE CAPACITY OF MEAN — SIZE  
CELLS INCLUDING CONNECTORS

S-1064

EnerSys

TYPE: GU-23 TO 31

Temp.  
77° F (25° C)

DATE: 1/26/84

SP. GR.  
1.215

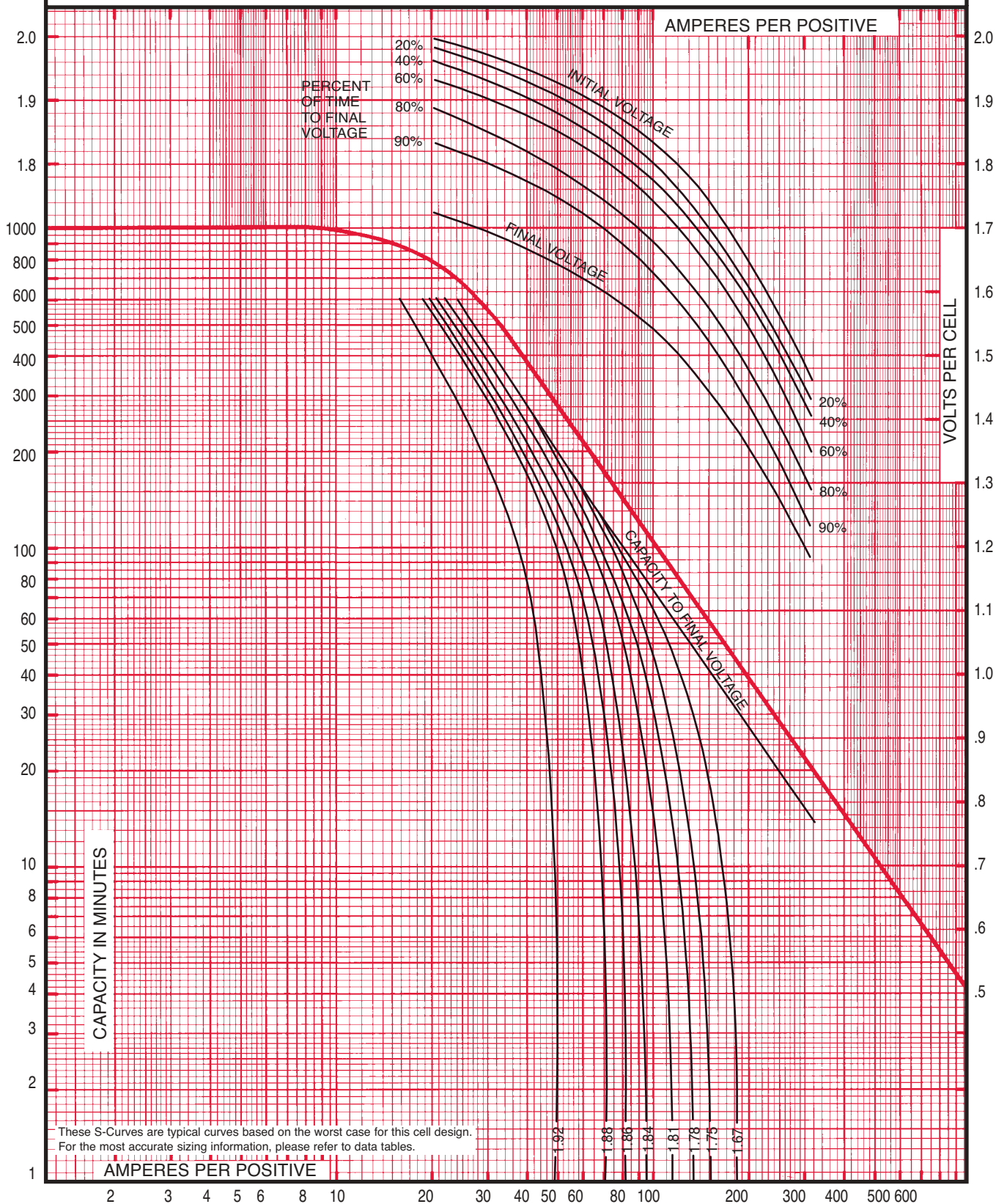

These S-Curves are typical curves based on the worst case for this cell design.  
For the most accurate sizing information, please refer to data tables.

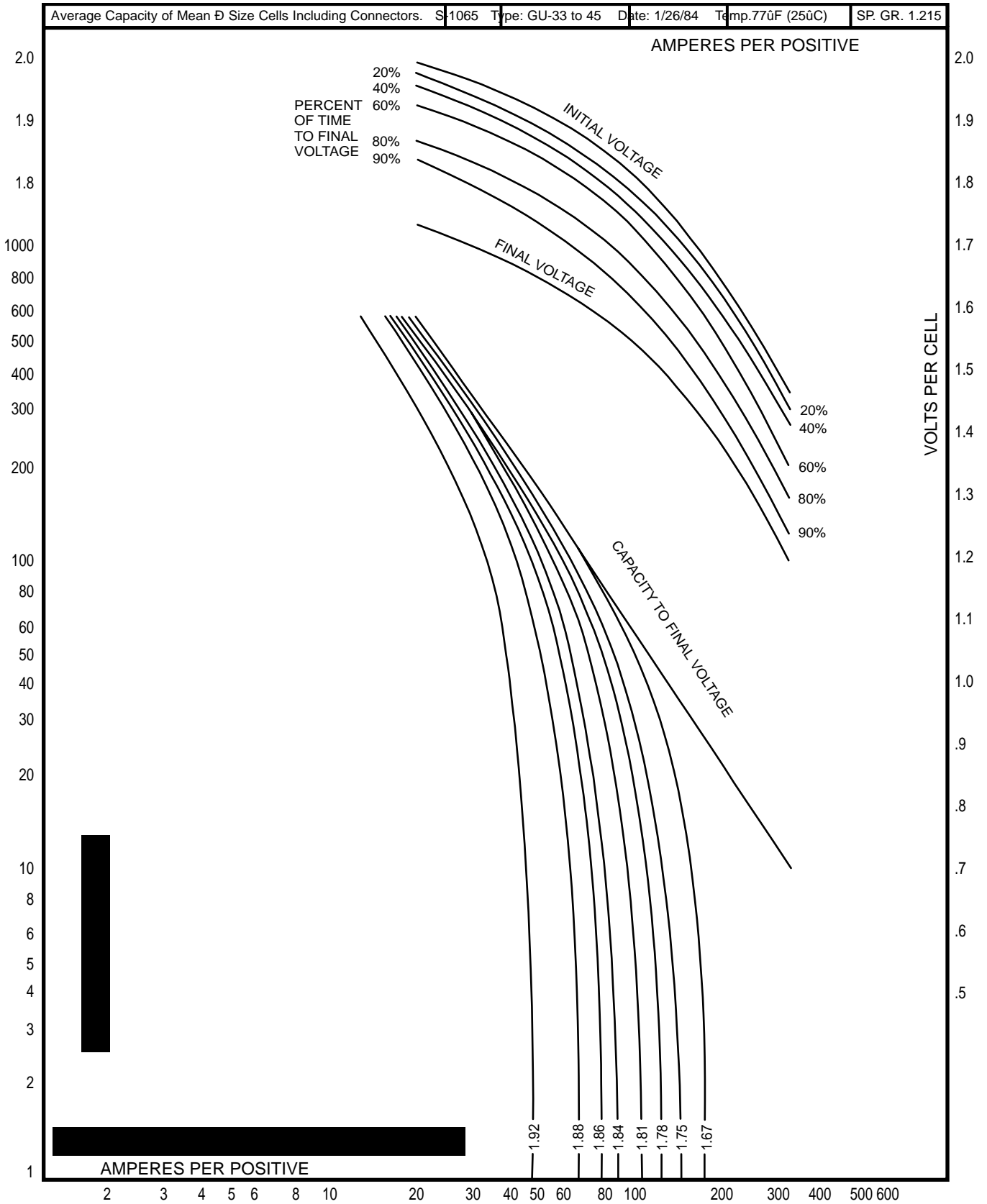

EnerSys  
P.O. Box 14145  
Reading, PA 19612-4145  
USA  
Tel: +1-610-208-1991  
+1-800-538-3627  
Fax: +1-610-372-8613

EnerSys EMEA  
Brussels, Belgium  
Tel: +32 (0)2 247 94 47  
  
EnerSys Asia  
Guangdong, China  
Tel: +86-755-2689 3639

